

# Low Cost Frequency Multipliers Using Surface Mount PIN Diodes

## Application Note 1054

### Introduction

PIN switching diodes with low values of transition time can multiply frequencies up to C-band similar to step recovery diodes (SRD). These diodes are available in the low-cost SOT-23 package. Several examples of surface mount multipliers using these PIN diodes are shown.

### Frequency Multipliers

Figure 1 shows three possible

sources for local oscillator power. A FET oscillator may be stabilized by a dielectric resonator. Problems may involve phase noise, and frequency stability and accuracy. A phase locked loop (PLL) arrangement involves a crystal source, a divider, mixer, voltage controlled oscillator, and a DC amplifier. The phase noise, excessive complexity, and cost rules out this option. The crystal oscillator followed by multipliers

and amplifiers would seem to be the logical choice for a local oscillator. However, there is an alternative low-cost solution using HP's HSMP-3820 diodes.

### Low-Cost Multiplier

A conventional step recovery diode multiplier consists of a diode, a biasing resistor, and matching filters at input and output. The output filter reflects

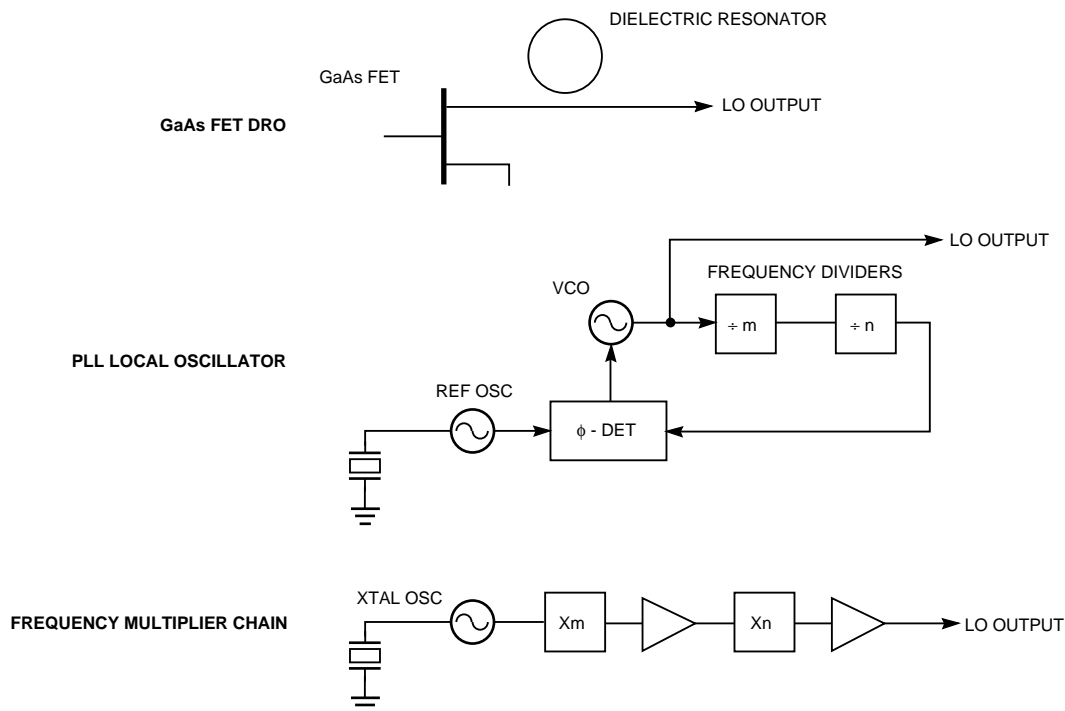

Figure 1. Local Oscillators.

the untuned harmonics back to the diode where they mix to form additional power at the tuned frequency.

Figure 2 shows this conventional multiplier as well as a multiplier using an anti-parallel pair of diodes. The additional diode results in the suppression of even order products, the enhancement of odd order products, and the elimination of the bias resistor.

Unfortunately the step recovery diodes currently are too expensive to allow the manufacture of a multiplier for high volume communications circuits. Fortunately certain kinds of epitaxial PIN switching diodes have characteristics which are very similar to

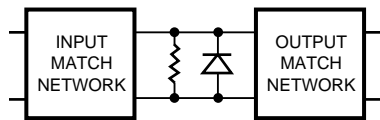

Figure 2a. Conventional Single Diode Multiplier.

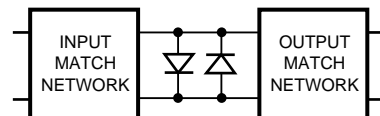

Figure 2b. Multiplier Using Anti-Parallel Pair of Diodes.

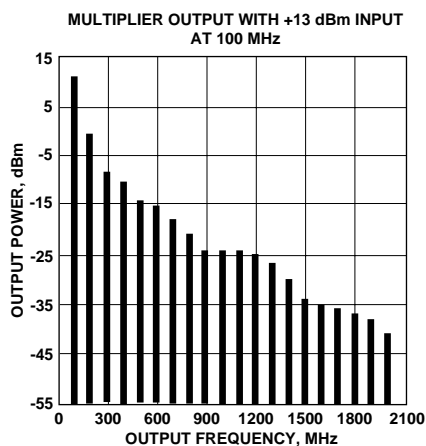

Figure 3. HSMP-3820 PIN Diode Multiplier.

those of a step recovery diode. A single HSMP-3820 PIN diode was mounted in shunt in a 50 ohm microstrip line and a 100 MHz signal at +13 dBm was applied to it. The resulting comb of harmonics was measured at the output of the circuit as shown in Figure 3. Bias resistor was 50 ohms. As can be seen, this epitaxial diode, with a 70 nanosecond lifetime, makes a relatively effective comb generator, especially when its high volume price is considered.

An HSMP-3822 diode pair was mounted in shunt in a 50 ohm microstrip line with terminals 1 and 2 connected to ground and terminal 3 soldered to the transmission line forming an antiparallel pair.

Since this product is made from two dice selected from adjacent positions on the wafer, the two diodes are very well matched. The result is shown in Figure 4. Note the suppression of even order harmonics.

When the two spectra are overlaid (Figure 5) it is easy to see the relative enhancement of odd order

products which the antiparallel pair produces. This diode pair was used to build two triplers and an X5 multiplier.

The first design was an X5 multiplier operating from a 100 MHz input at +13 dBm. The input was matched with a shunt inductor, and other passive components were added to the output to provide filtering of unwanted signals. The schematic of the final circuit is shown in Figure 6.

The measured output spectrum of the X5 multiplier is shown in Figure 7. As can be seen, there is a strong output at -5 dBm with unwanted signals suppressed by more than 20 dB.

The second multiplier built (Figure 8) was an X3 type, operating from a 600 MHz input. Input match was accomplished with a section of series 50 ohm line 24 degrees long with a shunt capacitor. The empirically derived output matching network consisted of a small capacitive "flag" (a very short open circuit stub) on the output 50 ohm line, near the diode pair.

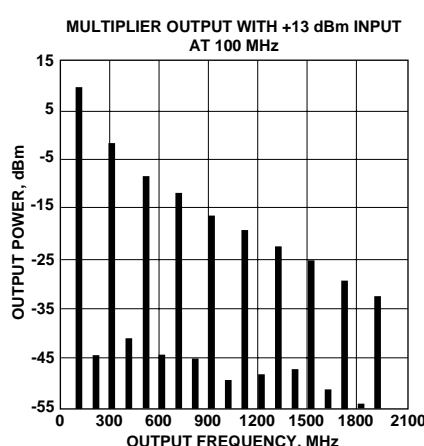

Figure 4. HSMP-3822 Anti-Parallel PIN Diode Multiplier.

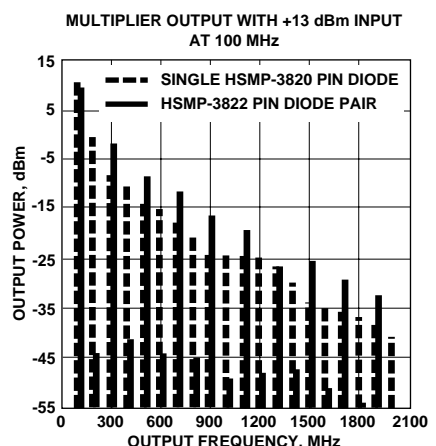

Figure 5. Multiplier Comparison.

The resulting output spectrum (Figure 9) has a strong output at 1.8 GHz. Unwanted sidebands are suppressed by more than 20 dB. This was the most efficient of the three multipliers built, with a conversion loss of 9 dB.

The final multiplier design (Figure 10) was another tripler, this one operating from an input of 1.8 GHz. The input impedance matching network/filter is shown, along with the empirically derived

output network which is also very simple.

The output spectrum is shown in Figure 11. As was the case with the lower frequency tripler, fundamental leakage is rather high, but this is easily removed with simple external filtering. The output at 5.4 GHz is adequately strong, with good suppression of the X2 product.

Figure 12 shows conversion loss as a function of drive level for the 3 multipliers. As was expected, the X5 network is the least efficient but relatively insensitive to input power. The most efficient circuit, the 600 MHz input X3, was the most sensitive to drive level. None of the multipliers was as efficient as a circuit made with an expensive, high quality SRD, but then these examples were fabricated using inexpensive PIN switching diodes.

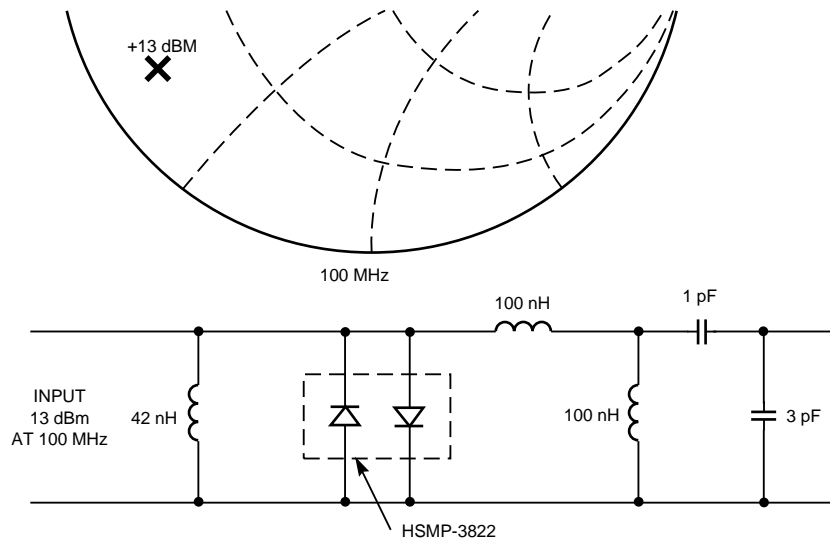

Figure 6. X5 Multiplier.

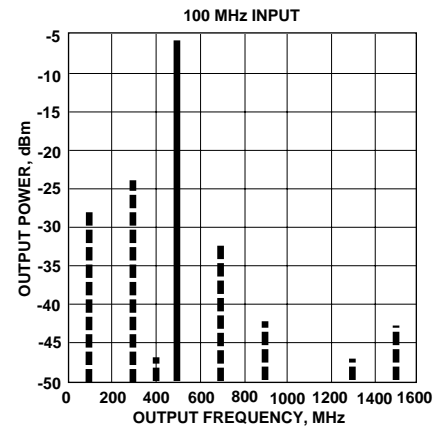

Figure 7. X5 Multiplier.

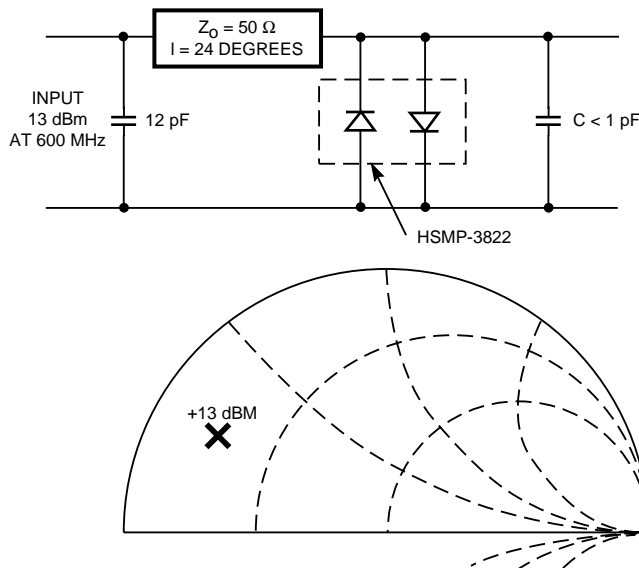

Figure 8. X3 Multiplier.

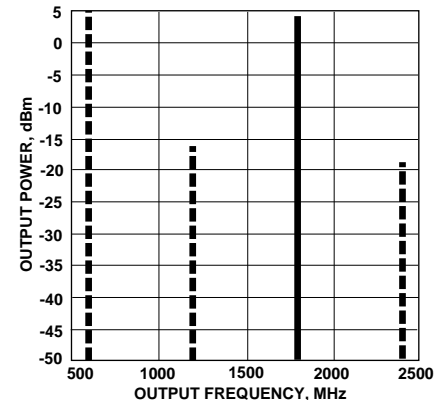
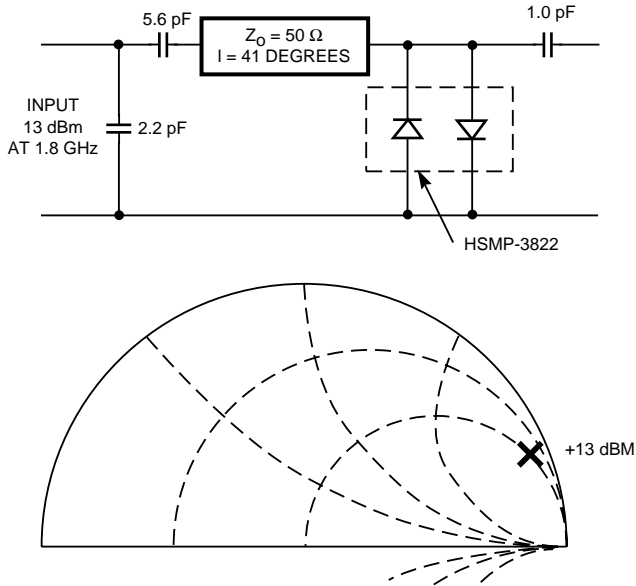
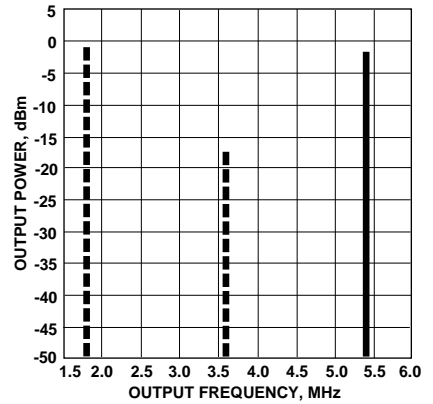

Figure 9. 600 MHz Tripler.



**Figure 10. 1.8 GHz Tripler.**



**Figure 11. 1.8 GHz Tripler.**

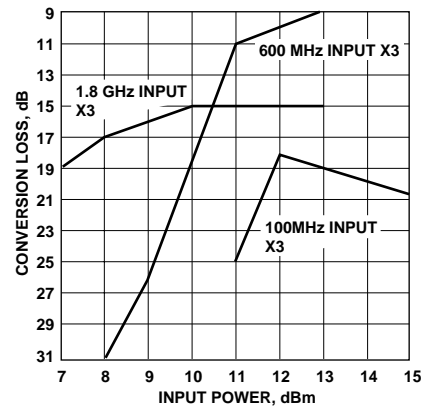

**Figure 12. Conversion Loss vs. Input Power.**

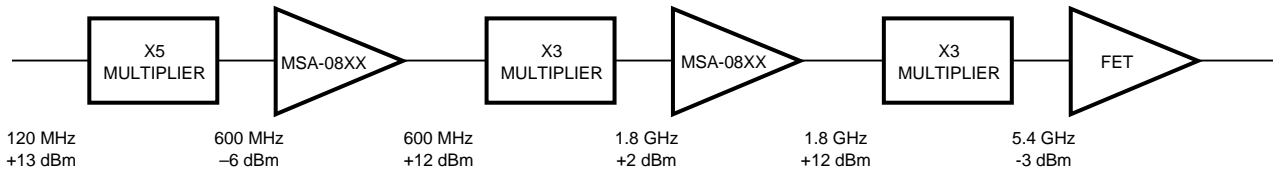

**Figure 13. X45 Multiplier.**

A possible application of these three multipliers is shown in Figure 13. The first multiplier is modified to operate from a 120 MHz crystal oscillator. Using two MSA silicon monolithic amplifiers, three inexpensive multipliers, and an output amplifier, sufficient power can be produced at 5.4 GHz for local oscillator applications.

[www.hp.com/go/rf](http://www.hp.com/go/rf)

For technical assistance or the location of your nearest Hewlett-Packard sales office, distributor or representative call:

**Americas/Canada:** 1-800-235-0312 or (408) 654-8675

**Far East/Australasia:** Call your local HP sales office.

**Japan:** (81 3) 3335-8152

**Europe:** Call your local HP sales office.

Data Subject to Change

Copyright © 1992 Hewlett-Packard Co.

Obsoletes 5091-4918E (9/92)

Printed in U.S.A. 5966-4998E (6/98)