

The RF MOSFET Line
RF Power
Field Effect Transistors
N-Channel Enhancement Mode MOSFETs

Designed primarily for wideband large-signal output and driver from 30–500 MHz.

- Low C_{rss} — 4.5 pF @ $V_{DS} = 28$ V
- MRF166C — Typical Performance at 400 MHz, 28 Vdc
Output Power = 20 W
Gain = 17 dB
Efficiency = 55%
- Optional 4-Lead Flange Package (MRF166)
- Replacement for Industry Standards such as MRF136, DV2820, BLF244, SD1902, and ST1001
- 100% Tested for Load Mismatch at all Phase Angles with 30:1 VSWR
- Facilitates Manual Gain Control, ALC and Modulation Techniques
- Excellent Thermal Stability, Ideally Suited for Class A Operation
- Circuit board photomaster available upon request by contacting RF Tactical Marketing in Phoenix, AZ.

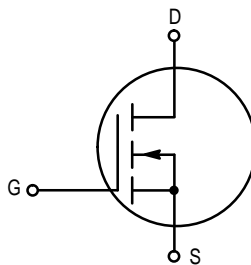

MRF166
MRF166C

20 W, 500 MHz
MOSFET
BROADBAND
RF POWER FETs

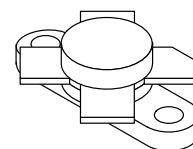

CASE 211-07, STYLE 2

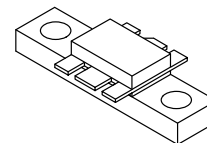

CASE 319-07, STYLE 3

MAXIMUM RATINGS

Rating	Symbol	Value	Unit
Drain–Gate Voltage	V_{DSS}	65	Vdc
Drain–Gate Voltage ($R_{GS} = 1.0$ M Ω)	V_{DGR}	65	Vdc
Gate–Source Voltage	V_{GS}	± 40	Vdc
Drain Current — Continuous	I_D	4.0	Adc
Total Device Dissipation @ $T_C = 25^\circ\text{C}$ Derate Above 25°C	P_D	70 0.4	Watts W/ $^\circ\text{C}$
Storage Temperature Range	T_{stg}	–65 to 150	$^\circ\text{C}$
Operating Junction Temperature	T_J	200	$^\circ\text{C}$

THERMAL CHARACTERISTICS

Characteristic	Symbol	Max	Unit
Thermal Resistance, Junction to Case	$R_{\theta JC}$	2.5	$^\circ\text{C}/\text{W}$

NOTE — **CAUTION** — MOS devices are susceptible to damage from electrostatic charge. Reasonable precautions in handling and packaging MOS devices should be observed.

ELECTRICAL CHARACTERISTICS ($T_C = 25^\circ\text{C}$ unless otherwise noted.)

Characteristic	Symbol	Min	Typ	Max	Unit
OFF CHARACTERISTICS					
Drain–Source Breakdown Voltage ($V_{GS} = 0\text{ V}$, $I_D = 5.0\text{ mA}$)	$V_{(BR)DSS}$	65	—	—	V
Zero Gate Voltage Drain Current ($V_{DS} = 28\text{ V}$, $V_{GS} = 0\text{ V}$)	I_{DSS}	—	—	1.0	mA
Gate–Source Leakage Current ($V_{GS} = 40\text{ V}$, $V_{DS} = 0\text{ V}$)	I_{GSS}	—	—	1.0	μA
ON CHARACTERISTICS					
Gate Threshold Voltage ($V_{DS} = 10\text{ V}$, $I_D = 25\text{ mA}$)	$V_{GS(th)}$	1.0	3.0	6.0	V
Forward Transconductance ($V_{DS} = 10\text{ V}$, $I_D = 1.5\text{ A}$)	g_{fs}	600	800	—	mhos
DYNAMIC CHARACTERISTICS					
Input Capacitance ($V_{DS} = 28\text{ V}$, $V_{GS} = 0\text{ V}$, $f = 1.0\text{ MHz}$)	C_{iss}	—	30	—	pF
Output Capacitance ($V_{DS} = 28\text{ V}$, $V_{GS} = 0\text{ V}$, $f = 1.0\text{ MHz}$)	C_{oss}	—	35	—	pF
Reverse Transfer Capacitance ($V_{DS} = 28\text{ V}$, $V_{GS} = 0\text{ V}$, $f = 1.0\text{ MHz}$)	C_{rss}	—	4.5	—	pF
FUNCTIONAL CHARACTERISTICS					
Noise Figure ($V_{DD} = 28\text{ V}$, $f = 30\text{ MHz}$, $I_{DQ} = 50\text{ mA}$)	NF	—	2.5	—	dB
MRF166C					
Common Source Power Gain ($V_{DD} = 28\text{ V}$, $P_{out} = 20\text{ W}$, $f = 400\text{ MHz}$, $I_{DQ} = 100\text{ mA}$)	G_{ps}	14	17	—	dB
Drain Efficiency ($V_{DD} = 28\text{ V}$, $P_{out} = 20\text{ W}$, $f = 400\text{ MHz}$, $I_{DQ} = 100\text{ mA}$)	η	50	55	—	%
Electrical Ruggedness ($V_{DD} = 28\text{ V}$, $P_{out} = 20\text{ W}$, $f = 400\text{ MHz}$, $I_{DQ} = 100\text{ mA}$, Load VSWR 30:1 at All Phase Angles)	ψ	No Degradation in Output Power			
MRF166					
Common Source Power Gain ($V_{DD} = 28\text{ V}$, $P_{out} = 20\text{ W}$, $f = 150\text{ MHz}$, $I_{DQ} = 25\text{ mA}$)	G_{ps}	15	19	—	dB
Drain Efficiency ($V_{DD} = 28\text{ V}$, $P_{out} = 20\text{ W}$, $f = 150\text{ MHz}$, $I_{DQ} = 25\text{ mA}$)	η	55	65	—	%
Electrical Ruggedness ($V_{DD} = 28\text{ V}$, $P_{out} = 20\text{ W}$, $f = 150\text{ MHz}$, $I_{DQ} = 25\text{ mA}$, Load VSWR 30:1 at All Phase Angles)	ψ	No Degradation in Output Power			
Series Equivalent Input Impedance ($V_{DD} = 28\text{ V}$, $P_{out} = 20\text{ W}$, $f = 150\text{ MHz}$, $I_{DQ} = 25\text{ mA}$)	Z_{in}	—	$3.99 - j12.2$	—	Ohms
Series Equivalent Output Impedance ($V_{DD} = 28\text{ V}$, $P_{out} = 20\text{ W}$, $f = 150\text{ MHz}$, $I_{DQ} = 25\text{ mA}$)	Z_{out}	—	$14.15 - j6.51$	—	Ohms

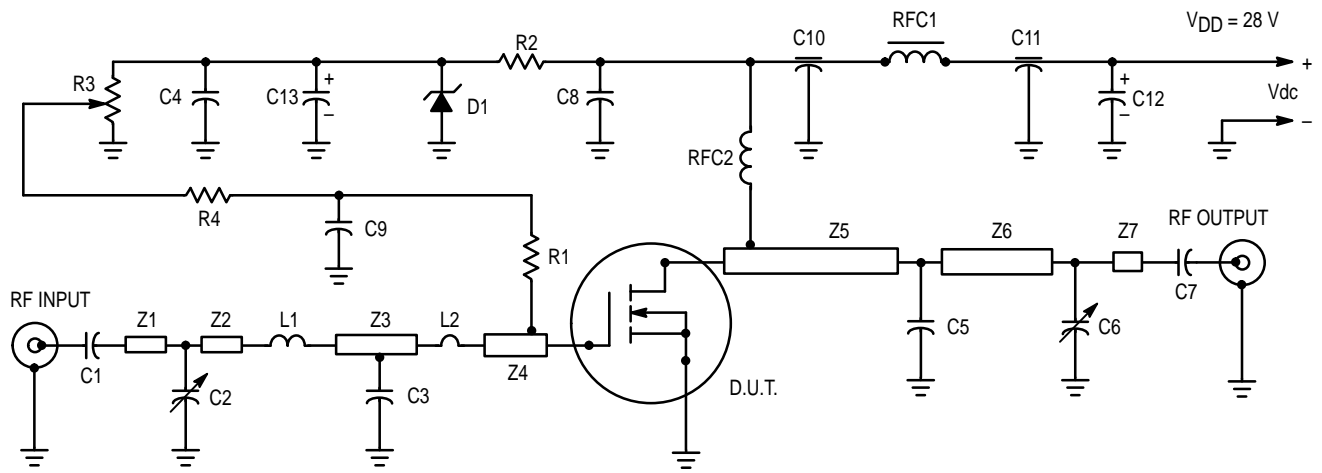

- C1, C7 — 270 pF Chip Capacitor
- C2, C6 — Johanson Trimmer Capacitor, 2–20 pF
- C3 — 21 pF Mini Unelco
- C4, C8, C9 — 0.01 μ F
- C5 — 18 pF Mini Unelco
- C10, C11 — 680 pF Feed Through
- C12, C13 — 50 μ F, 50 V
- D1 — 1N5925A Motorola Zener

Board Material — Teflon fiberglass
 2 oz. Copper clad both sides, $\epsilon_r = 2.55$
 0.060" Dielectric Thickness

- L1 — #18 AWG, 2 Turns, 0.25" ID 0.15" Wide
- L2 — #18 AWG Hairpin 0.7" long, bend into hairpin
- RFC1 — Ferroxcube VK200–19/4B
- RFC2 — 18 Turns #18 AWG Enameled, 0.3" ID
- R1 — 220 Ω 1/2 Watt
- R2 — 1.8 k Ω 1/4 Watt
- R3 — 10 k Ω , 10 Turns Bourns
- R4 — 10 k 1/4 Watt
- Z1 — Microstrip Line 0.150" wide, 0.420" long
- Z2 — Microstrip Line 0.150" wide, 0.350" long
- Z3 — Microstrip Line 0.150" wide, 0.350" long
- Z4 — Microstrip Line 0.150" wide, 0.450" long
- Z5 — Microstrip Line 0.150" wide, 1.1" long
- Z6 — Microstrip Line 0.150" wide, 0.650" long
- Z7 — Microstrip Line 0.150" wide, 0.200" long

Figure 1. MRF166C 400 MHz Test Circuit

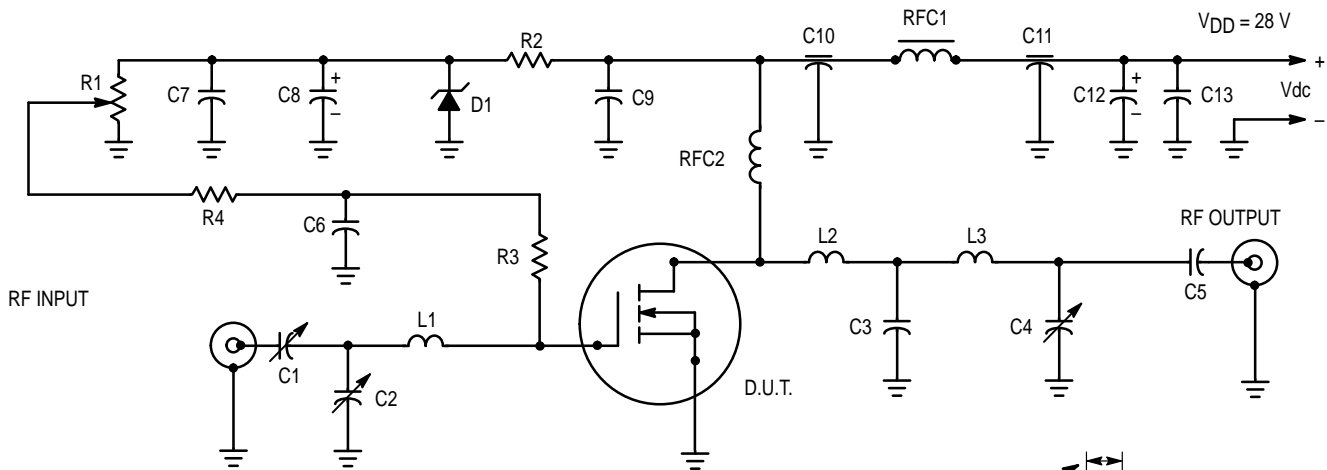

- C1, C2 — 406 ARCO
- C3 — 39 pF ATC 100 Mil Chip Cap
- C4 — 403 ARCO
- C5 — 470 pF ATC 100 Mil Chip Cap
- C6, C7, C9, C13 — 0.01 μ F
- C8, C12 — 50 μ F, 50 V
- C10, C11 — 680 pF Feed Through
- D1 — 1N5925A Motorola Zener

- L1 — #20 AWG 2 Turns, 0.235" ID, 0.10" OD
 - L2 — #18 AWG 2 Turns, 0.225" ID, 0.22" OD
 - L3 — #18 AWG 2 Turns, 0.325" ID, 0.13" OD
 - RFC1 — Ferroxcube VK200–19/4B
 - RFC2 — 18 Turns #18 AWG Enameled, 0.3" ID
 - R1 — 10 k Ω , 10 Turn Bourns
 - R2 — 1.8 k Ω 1/4 Watt
 - R3 — 120 Ω 1/2 Watt
 - R4 — 10 k Ω 1/4 Watt
- Board Material — 0.062" G10, 2 oz Cu Clad Double Sided

Figure 2. MRF166 150 MHz Test Circuit

TYPICAL CHARACTERISTICS

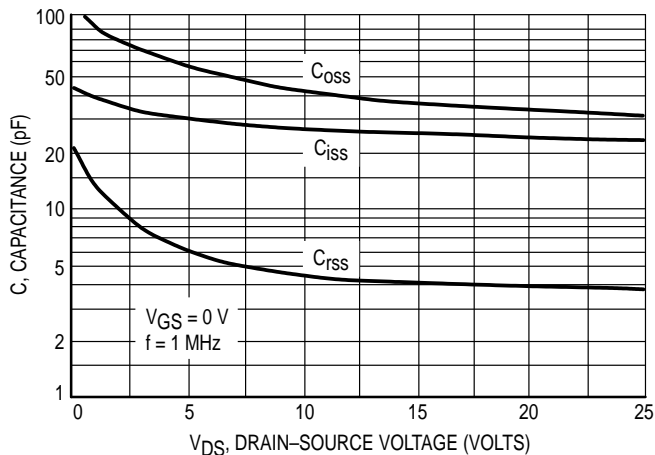

Figure 3. Capacitance versus Drain-Source Voltage

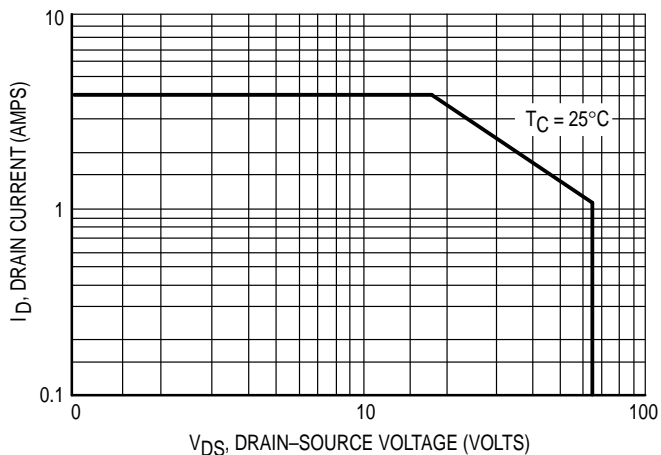

Figure 4. DC Safe Operating Area

MRF166

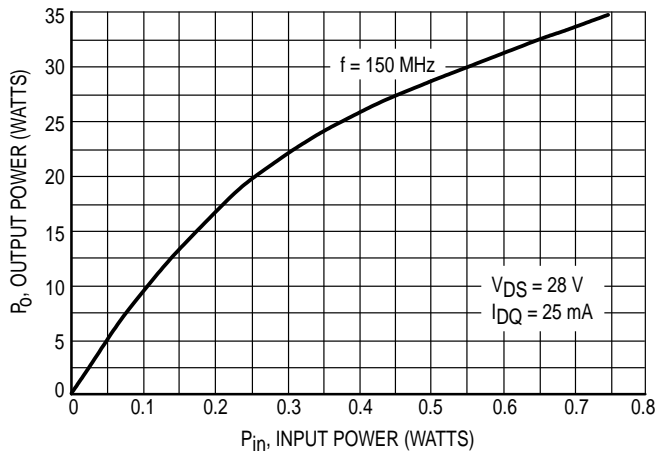

Figure 5. Output Power versus Input Power

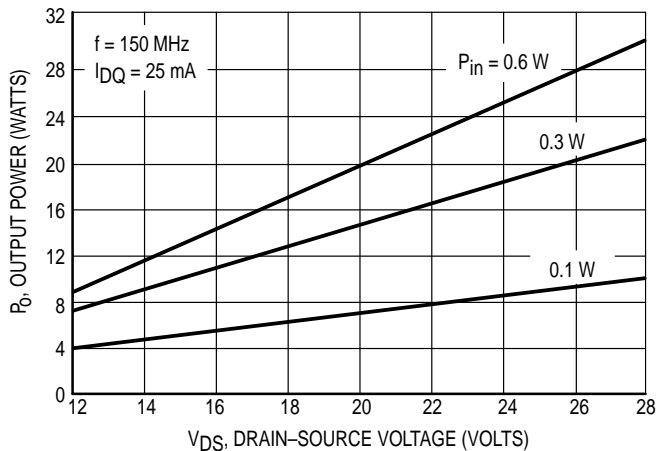

Figure 6. Output Power versus Voltage

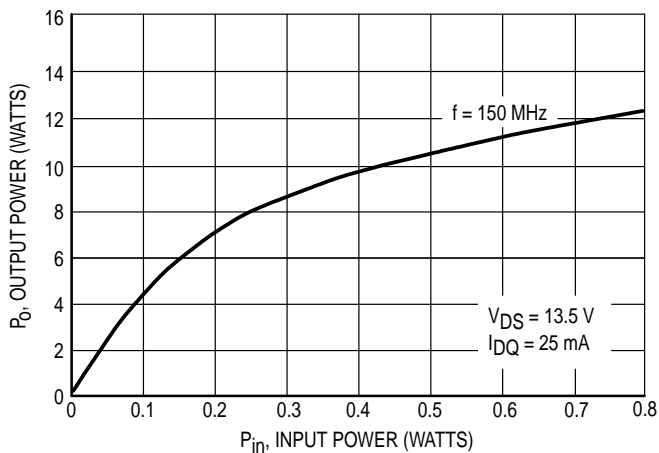

Figure 7. Output Power versus Input Power

MRF166C

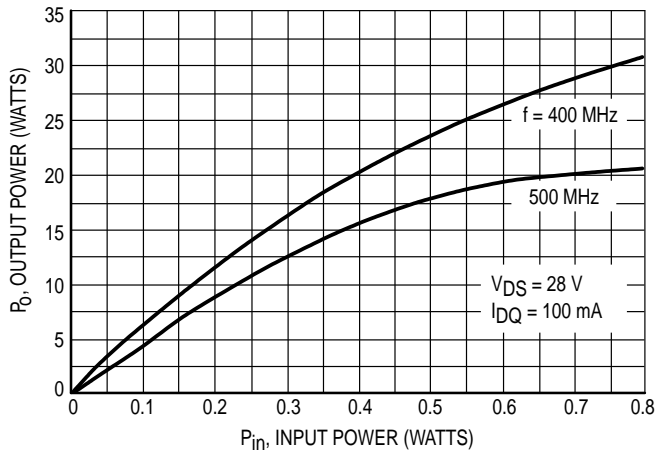

Figure 8. Output Power versus Input Power

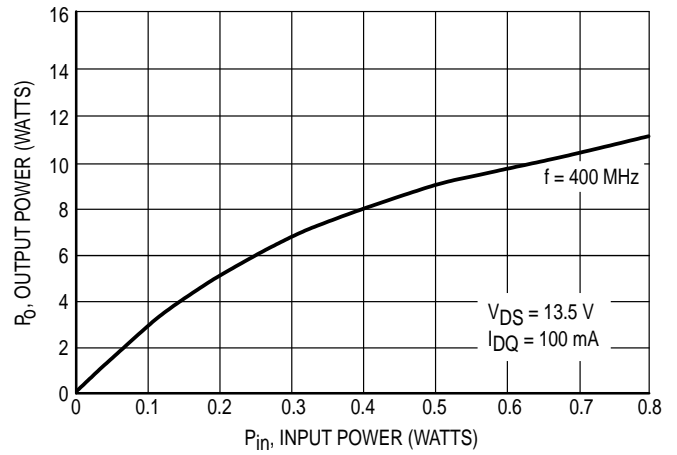

Figure 9. Output Power versus Input Power

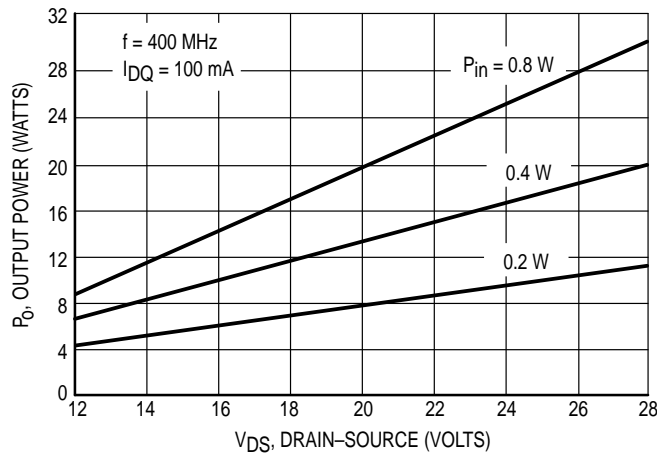

Figure 10. Output Power versus Voltage

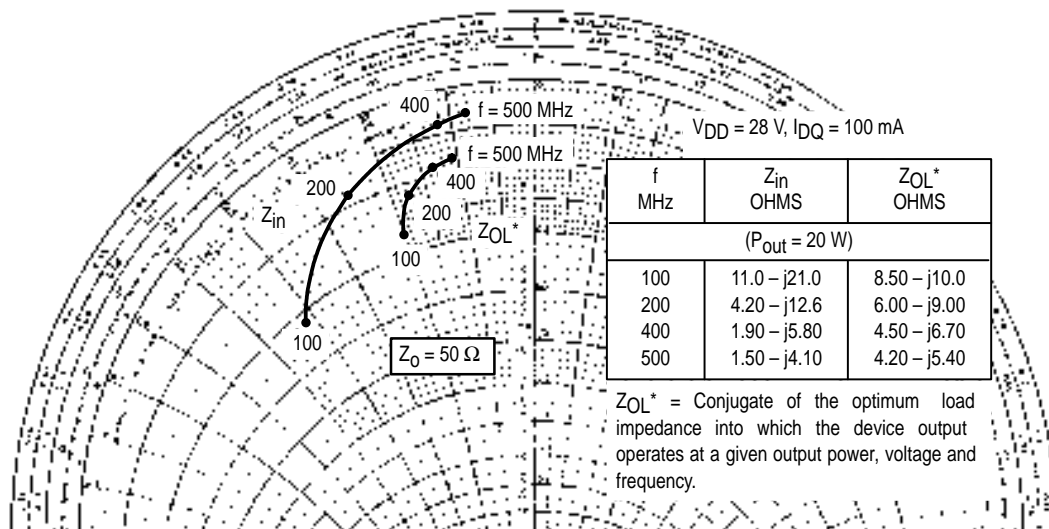
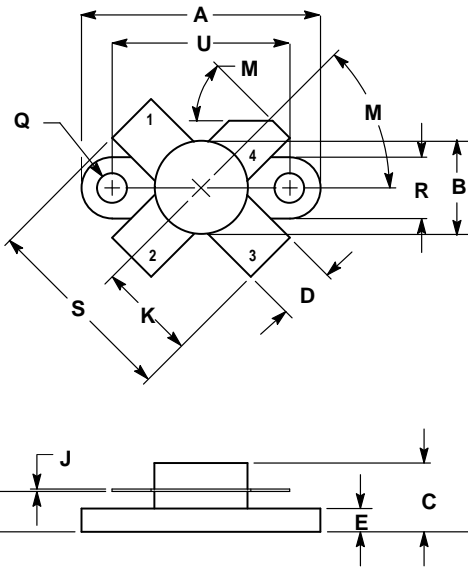

Figure 11. Series Equivalent Input and Output Impedance

PACKAGE DIMENSIONS



- NOTES:
 1. DIMENSIONING AND TOLERANCING PER ANSI Y14.5M, 1982.
 2. CONTROLLING DIMENSION: INCH.

DIM	INCHES		MILLIMETERS	
	MIN	MAX	MIN	MAX
A	0.960	0.990	24.39	25.14
B	0.370	0.390	9.40	9.90
C	0.229	0.281	5.82	7.13
D	0.215	0.235	5.47	5.96
E	0.085	0.105	2.16	2.66
H	0.150	0.108	3.81	4.57
J	0.004	0.006	0.11	0.15
K	0.395	0.405	10.04	10.28
M	40°	50°	40°	50°
Q	0.113	0.130	2.88	3.30
R	0.245	0.255	6.23	6.47
S	0.790	0.810	20.07	20.57
U	0.720	0.730	18.29	18.54

- STYLE 2:
 PIN 1. SOURCE
 2. GATE
 3. SOURCE
 4. DRAIN

**CASE 211-07
 ISSUE N**

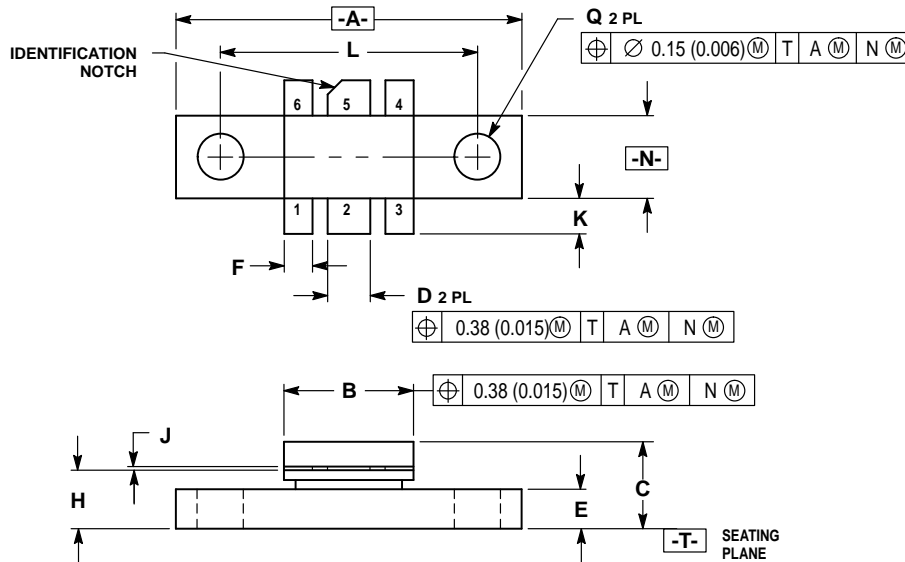

- NOTES:
 1. DIMENSIONING AND TOLERANCING PER ANSI Y14.5M, 1982.
 2. CONTROLLING DIMENSION: INCH.

DIM	INCHES		MILLIMETER	
	MIN	MAX	MIN	MAX
A	0.965	0.985	24.52	25.01
B	0.355	0.375	9.02	9.52
C	0.230	0.260	5.85	6.60
D	0.115	0.125	2.93	3.17
E	0.102	0.114	2.59	2.90
F	0.075	0.085	1.91	2.15
H	0.160	0.170	4.07	4.31
J	0.004	0.006	0.11	0.15
K	0.090	0.110	2.29	2.79
L	0.725 BSC		18.42 BSC	
N	0.225	0.241	5.72	6.12
Q	0.125	0.135	3.18	3.42

- STYLE 3:
 PIN 1. SOURCE (COMMON)
 2. GATE (INPUT)
 3. SOURCE (COMMON)
 4. SOURCE (COMMON)
 5. DRAIN (OUTPUT)
 6. SOURCE (COMMON)

**CASE 319-07
 ISSUE M**

Motorola reserves the right to make changes without further notice to any products herein. Motorola makes no warranty, representation or guarantee regarding the suitability of its products for any particular purpose, nor does Motorola assume any liability arising out of the application or use of any product or circuit, and specifically disclaims any and all liability, including without limitation consequential or incidental damages. "Typical" parameters can and do vary in different applications. All operating parameters, including "Typicals" must be validated for each customer application by customer's technical experts. Motorola does not convey any license under its patent rights nor the rights of others. Motorola products are not designed, intended, or authorized for use as components in systems intended for surgical implant into the body, or other applications intended to support or sustain life, or for any other application in which the failure of the Motorola product could create a situation where personal injury or death may occur. Should Buyer purchase or use Motorola products for any such unintended or unauthorized application, Buyer shall indemnify and hold Motorola and its officers, employees, subsidiaries, affiliates, and distributors harmless against all claims, costs, damages, and expenses, and reasonable attorney fees arising out of, directly or indirectly, any claim of personal injury or death associated with such unintended or unauthorized use, even if such claim alleges that Motorola was negligent regarding the design or manufacture of the part. Motorola and  are registered trademarks of Motorola, Inc. Motorola, Inc. is an Equal Opportunity/Affirmative Action Employer.

Literature Distribution Centers:

USA: Motorola Literature Distribution; P.O. Box 20912; Phoenix, Arizona 85036.

EUROPE: Motorola Ltd.; European Literature Centre; 88 Tanners Drive, Blakelands, Milton Keynes, MK14 5BP, England.

JAPAN: Nippon Motorola Ltd.; 4-32-1, Nishi-Gotanda, Shinagawa-ku, Tokyo 141, Japan.

ASIA PACIFIC: Motorola Semiconductors H.K. Ltd.; Silicon Harbour Center, No. 2 Dai King Street, Tai Po Industrial Estate, Tai Po, N.T., Hong Kong.



MRF166/D

