

MC3359

Low Power Narrowband FM IF

... includes oscillator, mixer, limiting amplifier, AFC, quadrature discriminator, op/amp, squelch, scan control, and mute switch. The MC3359 is designed to detect narrowband FM signals using a 455 kHz ceramic filter for use in FM dual conversion communications equipment. The MC3359 is similar to the MC3357 except that the MC3359 has an additional limiting IF stage, an AFC output, and an opposite polarity Broadcast Detector. The MC3359 also requires fewer external parts. For low cost applications requiring V_{CC} below 6.0 V, the MC3361BP,BD are recommended. For applications requiring a fixed, tuned, ceramic quadrature resonator, use the MC3357. For applications requiring dual conversion and RSSI, refer to these devices; MC3335, MC3362 and MC3363.

- Low Drain Current: 3.6 mA (Typical) @ $V_{CC} = 6.0$ Vdc
- Excellent Sensitivity: Input Limiting Voltage –
– 3.0 dB = 2.0 μ V (Typical)
- Low Number of External Parts Required
- For Low Voltage and RSSI, use the MC3371

HIGH GAIN LOW POWER FM IF

SEMICONDUCTOR TECHNICAL DATA

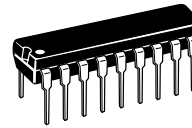

P SUFFIX
PLASTIC PACKAGE
CASE 707

DW SUFFIX
PLASTIC PACKAGE
CASE 751D
(SO-20L)

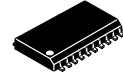

ORDERING INFORMATION

Device	Operating Temperature Range	Package
MC3359DW	$T_A = -30$ to $+70^\circ\text{C}$	SO-20L
MC3359P		Plastic DIP

Figure 1. Simplified Application in a Scanner Receiver

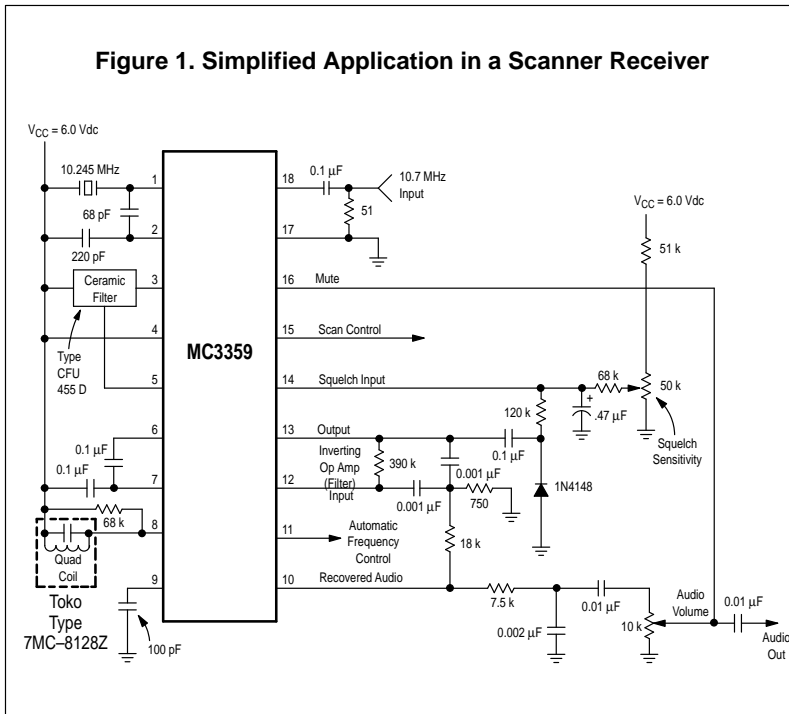
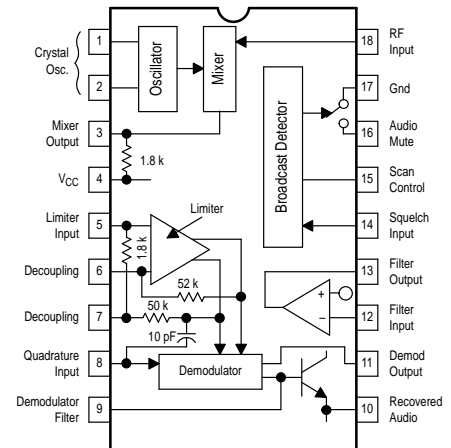
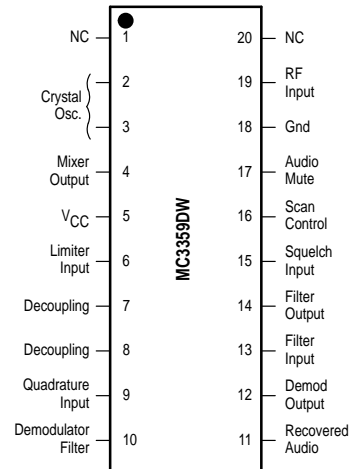

Figure 2. Pin Connections and Functional Block Diagram



CASE 707



CASE 751D

MC3359

MAXIMUM RATINGS (T_A = 25°C, unless otherwise noted)

Rating	Pin	Symbol	Value	Unit
Power Supply Voltage	4	V _{CC(max)}	12	Vdc
Operating Supply Voltage Range	4	V _{CC}	6 to 9	Vdc
Input Voltage (V _{CC} ≥ 6.0 Volts)	18	V ₁₈	1.0	V _{rms}
Mute Function	16	V ₁₆	-0.7 to 12	V _{pk}
Junction Temperature	-	T _J	150	°C
Operating Ambient Temperature Range	-	T _A	-30 to +70	°C
Storage Temperature Range	-	T _{stg}	-65 to +150	°C

ELECTRICAL CHARACTERISTICS (V_{CC} = 6.0 Vdc, f₀ = 10.7 MHz, Δf = ±3.0 kHz, f_{mod} = 1.0 kHz, 50 Ω source, T_A = 25°C test circuit of Figure 3, unless otherwise noted)

Characteristics	Min	Typ	Max	Units
Drain Current (Pins 4 and 8)				mA
Squelch Off	-	3.6	6.0	
Squelch On	-	5.4	7.0	
Input for 20 dB Quieting	-	8.0	-	μVrms
Input for -3.0 dB Limiting	-	2.0	-	μVrms
Mixer Voltage Gain (Pin 18 to Pin 3, Open)	-	46	-	
Mixer Third Order Intercept, 50 Ω Input	-	-1.0	-	dBm
Mixer Input Resistance	-	3.6	-	kΩ
Mixer Input Capacitance	-	2.2	-	pF
Recovered Audio, Pin 10 (Input Signal 1.0 mVrms)	450	700	-	mVrms
Detector Center Frequency Slope, Pin 10	-	0.3	-	V/kHz
AFC Center Slope, Pin 11, Unloaded	-	12	-	V/kHz
Filter Gain (test circuit of Figure 3)	40	51	-	dB
Squelch Threshold, Through 10K to Pin 14	-	0.62	-	Vdc
Scan Control Current, Pin 15				μA
Pin 14 - High	-	0.01	1.0	
- Low	2.0	2.4	-	mA
Mute Switch Impedance Pin 16 to Ground				Ω
Pin 14 - High	-	5.0	10	
- Low	-	1.5	-	MΩ

Figure 3. Test Circuit

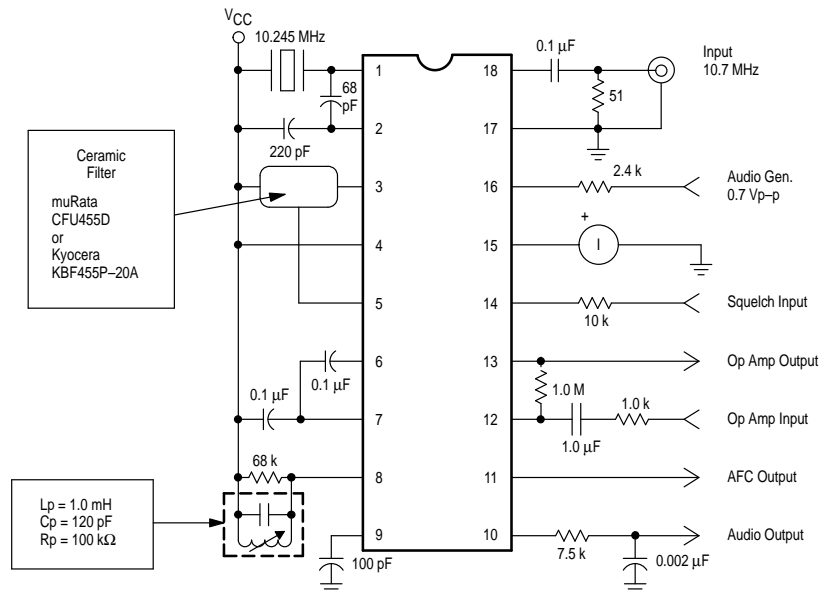

Figure 4. Mixer Voltage Gain

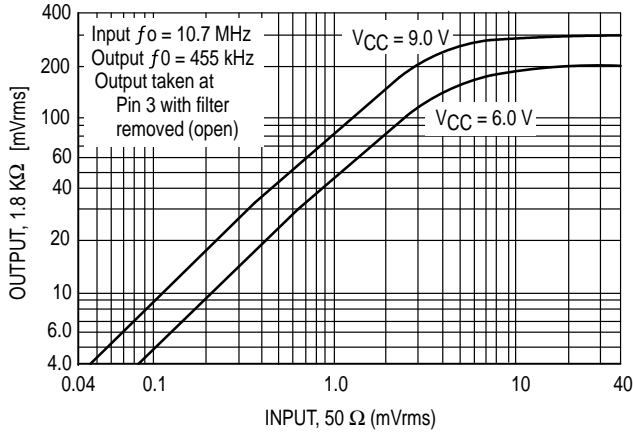

Figure 5. Limiting IF Frequency Response

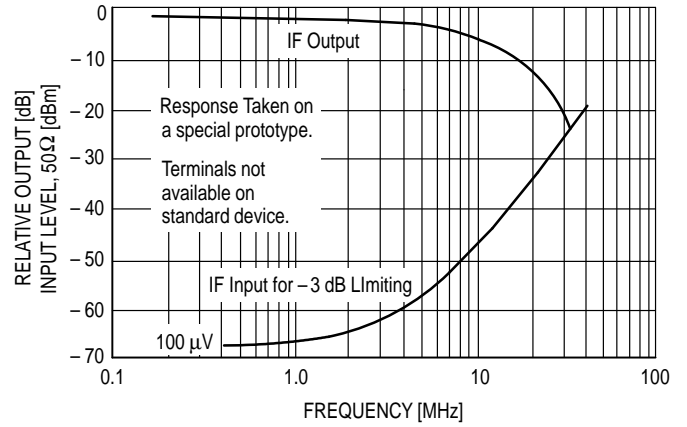

Figure 6. Mixer Third Order Intermodulation Performance

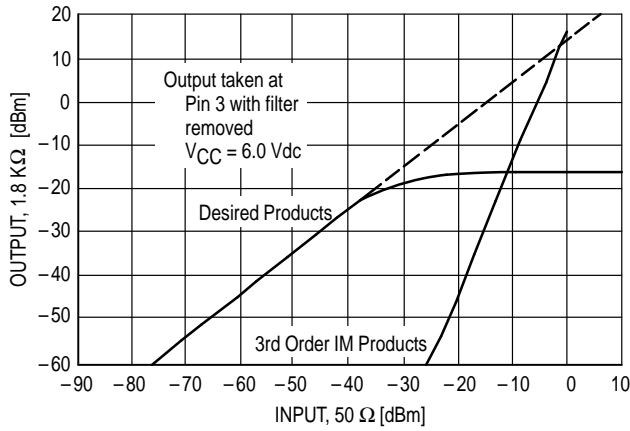

Figure 7. Detector and AFC Responses

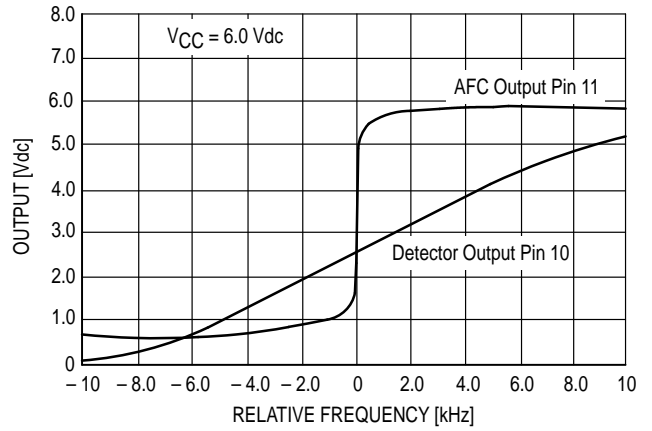

Figure 8. Relative Mixer Gain

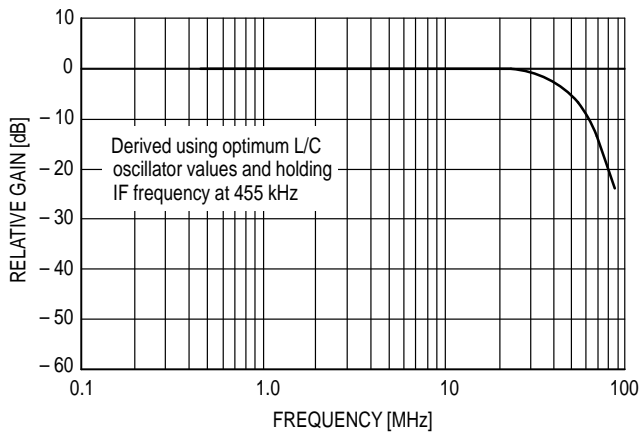

Figure 9. Overall Gain, Noise, and AM Rejection

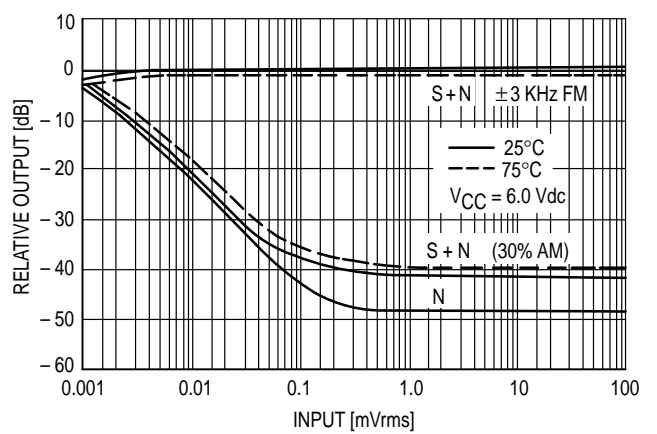

Figure 10. Output Components of Signal, Noise, and Distortion

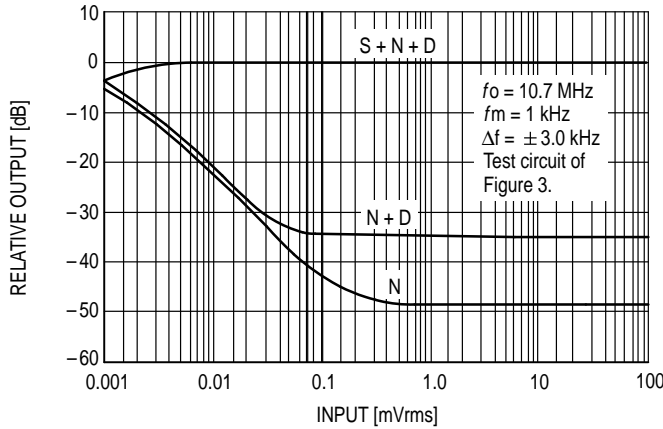

Figure 11. Audio Output and Total Current Drain versus Supply Voltage

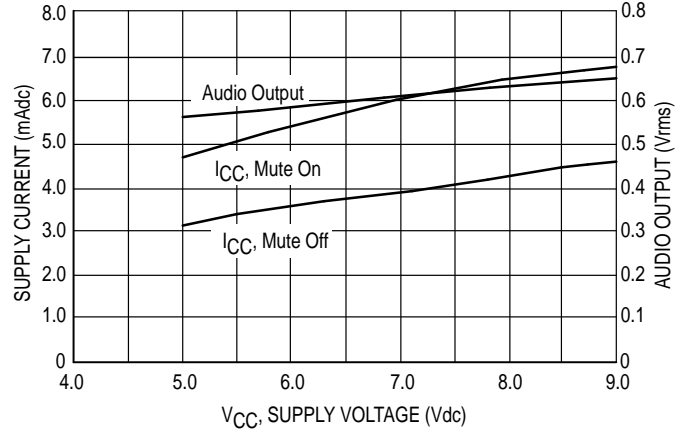

Figure 12. L/C Oscillator, Temperature and Power Supply Sensitivity

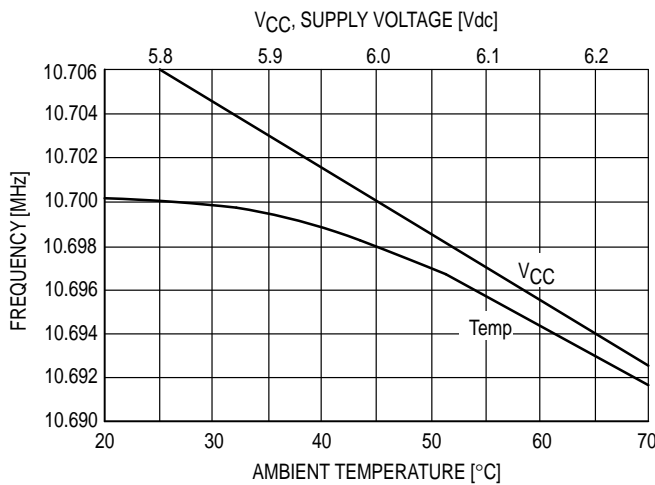

Figure 13. Op Amp Gain and Phase Response

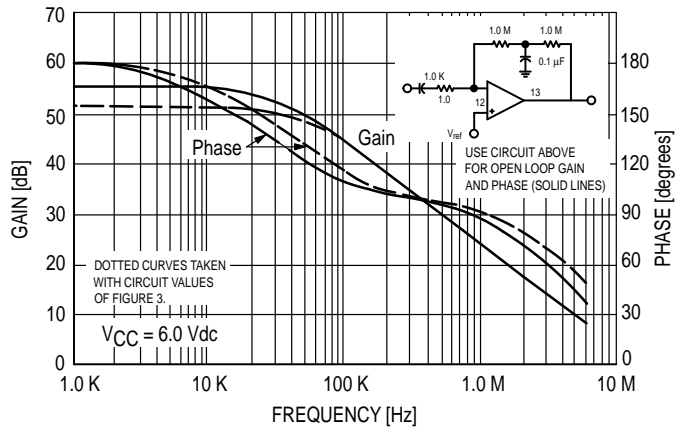

Figure 14. L/C Oscillator Recommended Component Values

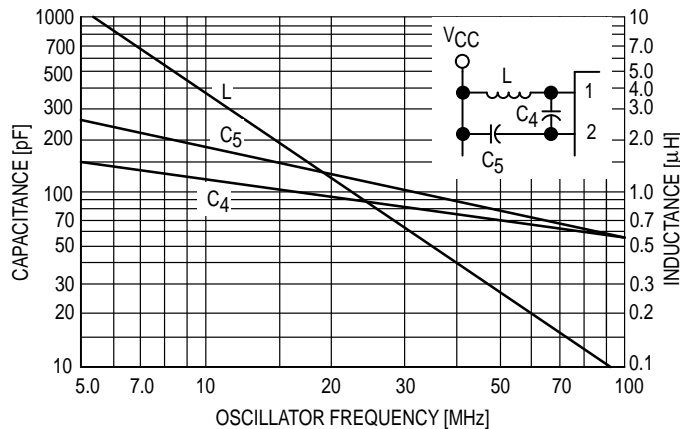

Figure 15. The Op Amp as a Bandpass Filter

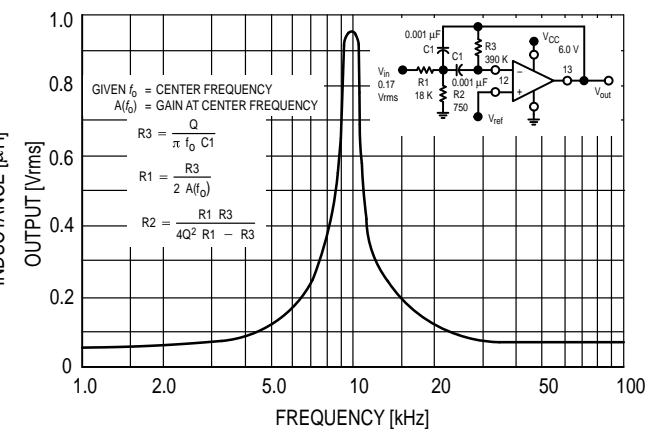
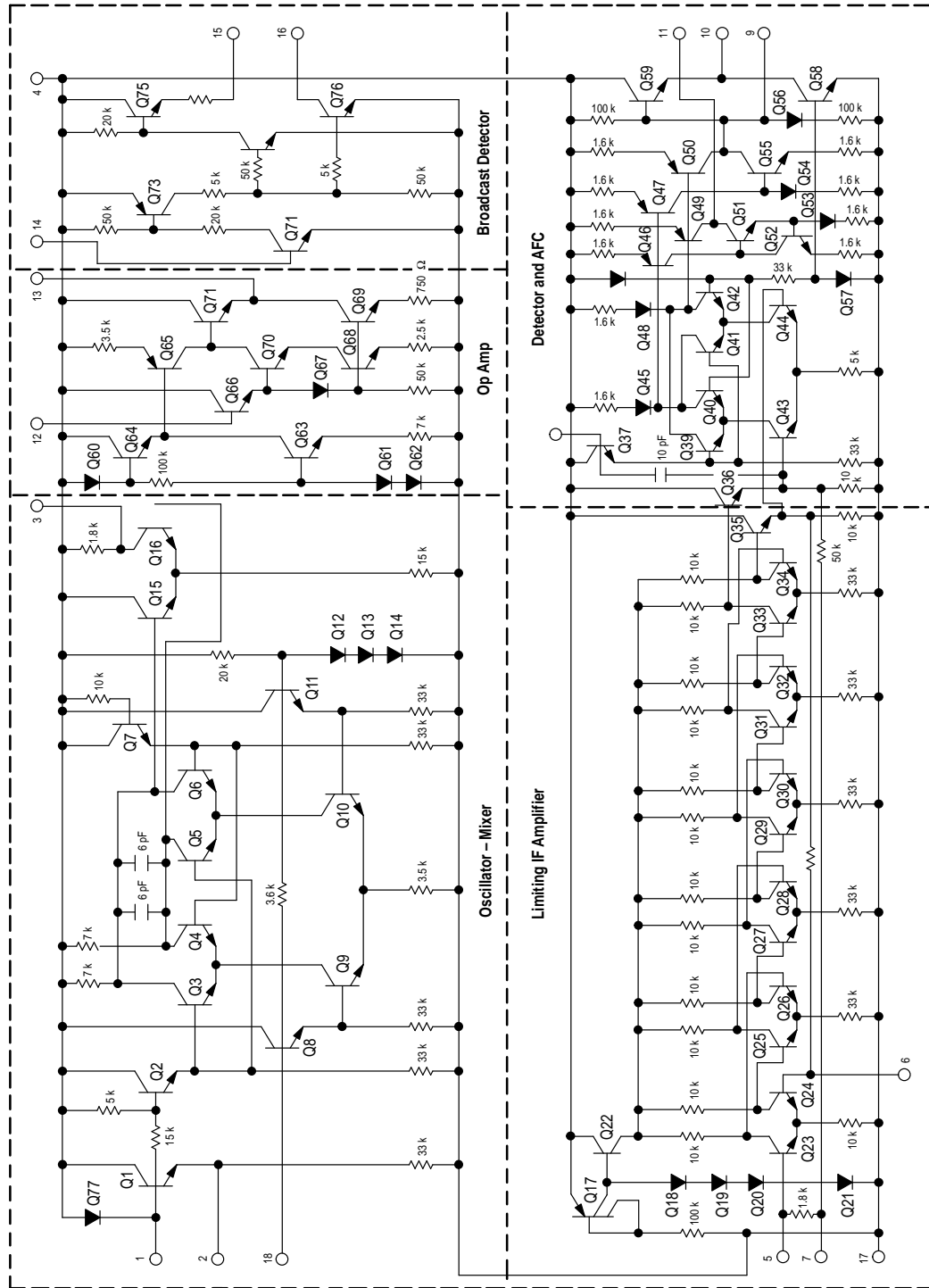

Figure 16. Representative Schematic Diagram



CIRCUIT DESCRIPTION

The MC3359 is a low-power FM IF circuit designed primarily for use in voice-communication scanning receivers. It is also finding a place in narrowband data links.

In the typical application (Figure 1), the mixer-oscillator combination converts the input frequency (10.7 MHz) down to 455 kHz, where, after external bandpass filtering, most of the amplification is done. The audio is recovered using a conventional quadrature FM detector. The absence of an input signal is indicated by the presence of noise above the desired audio frequencies. This "noise band" is monitored by an active filter and a detector. A squelch-trigger circuit indicates the presence of noise (or a tone) by an output which can be used to control scanning. At the same time, an internal switch is operated which can be used to mute the audio.

APPLICATIONS INFORMATION

The oscillator is an internally biased Colpitts type with the collector, base, and emitter connections at Pin 4, 1 and 2, respectively. The crystal is used in fundamental mode, calibrated for parallel resonance at 32 pF load capacitance. In theory this means that the two capacitors in series should be 32 pF, but in fact much larger values do not significantly affect the oscillator frequency, and provide higher oscillator output.

The oscillator can also be used in the conventional L/C Colpitts configuration without loss of mixer conversion gain. This oscillator is, of course, much more sensitive to voltage and temperature as shown in Figure 12. Guidelines for choosing L and C values are given in Figure 14.

The mixer is doubly balanced to reduce spurious responses. The mixer measurements of Figure 4 and 6 were made using an external 50 Ω source and the internal 1.8 k at Pin 3. Voltage gain curves at several V_{CC} voltages are shown in Figure 4. The Third Order Intercept curves of Figure 6 are shown using the conventional dBm scales. Measured power gain (with the 50 Ω input) is approximately 18 dB but the useful gain is much higher because the mixer input impedance is over 3 k Ω . Most applications will use a 330 Ω 10.7 MHz crystal filter ahead of the mixer. For higher frequencies, the relative mixer gain is given in Figure 8.

Following the mixer, a ceramic bandpass filter is recommended. The 455 kHz types come in bandwidths from ± 2 kHz to ± 15 kHz and have input and output impedances of 1.5 k to 2.0 k. For this reason, the Pin 5 input to the 6 stage limiting IF has an internal 1.8 k resistor. The IF has a 3 dB

limiting sensitivity of approximately 100 μ V at Pin 5 and a useful frequency range of about 5 MHz as shown in Figure 5. The frequency limitation is due to the high resistance values in the IF, which were necessary to meet the low power requirement. The output of the limiter is internally connected to the quadrature detector, including the 10 pF quadrature capacitor. Only a parallel L/C is needed externally from Pin 8 to V_{CC} . A shunt resistance can be added to widen the peak separation of the quadrature detector.

The detector output is amplified and buffered to the audio output, Pin 10, which has an output impedance of approximately 300 Ω . Pin 9 provides a high impedance (50 k) point in the output amplifier for application of a filter or de-emphasis capacitor. Pin 11 is the AFC output, with high gain and high output impedance (1 M). If not needed, it should be grounded, or it can be connected to Pin 9 to double the recovered audio. The detector and AFC responses are shown in Figure 7.

Overall performance of the MC3359 from mixer input to audio output is shown in Figure 9 and 10. The MC3359 can also be operated in "single conversion" equipment; i.e., the mixer can be used as a 455 kHz amplifier. The oscillator is disabled by connecting Pin 1 to Pin 2. In this mode, the overall performance is identical to the 10.7 MHz results of Figure 9.

A simple inverting op amp is provided with an output at Pin 13 providing dc bias (externally) to the input at Pin 12, which is referred internally to 2.0 V. A filter can be made with external impedance elements to discriminate between frequencies. With an external AM detector, the filtered audio signal can be checked for the presence of either noise above the normal audio, or a tone signal.

The open loop response of this op amp is given in Figure 13. Bandpass filter design information is provided in Figure 15.

A low bias to Pin 14 sets up the squelch-trigger circuit so that Pin 15 is high, a source of at least 2.0 mA, and the audio mute (Pin 16) is open-circuit. If Pin 14 is raised to 0.7 V by the noise or tone detector, Pin 15 becomes open circuit and Pin 16 is internally short circuited to ground. There is no hysteresis. Audio muting is accomplished by connecting Pin 16 to a high-impedance ground-reference point in the audio path between Pin 10 and the audio amplifier. No dc voltage is needed, in fact it is not desirable because audio "thump" would result during the muting function. Signal swing greater than 0.7 V below ground on Pin 16 should be avoided.

MC3359

OUTLINE DIMENSIONS

P SUFFIX PLASTIC PACKAGE CASE 707-02 ISSUE C

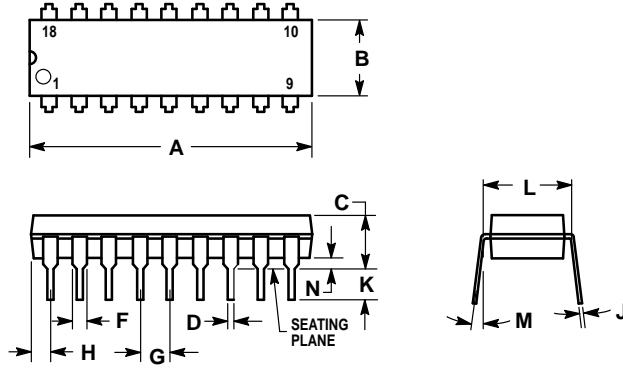

NOTES:

1. POSITIONAL TOLERANCE OF LEADS (D), SHALL BE WITHIN 0.25 (0.010) AT MAXIMUM MATERIAL CONDITION, IN RELATION TO SEATING PLANE AND EACH OTHER.
2. DIMENSION L TO CENTER OF LEADS WHEN FORMED PARALLEL.
3. DIMENSION B DOES NOT INCLUDE MOLD FLASH.

DIM	MILLIMETERS		INCHES	
	MIN	MAX	MIN	MAX
A	22.22	23.24	0.875	0.915
B	6.10	6.60	0.240	0.260
C	3.56	4.57	0.140	0.180
D	0.36	0.56	0.014	0.022
F	1.27	1.78	0.050	0.070
G	2.54 BSC		0.100 BSC	
H	1.02	1.52	0.040	0.060
J	0.20	0.30	0.008	0.012
K	2.92	3.43	0.115	0.135
L	7.62 BSC		0.300 BSC	
M	0°	15°	0°	15°
N	0.51	1.02	0.020	0.040

DW SUFFIX PLASTIC PACKAGE CASE 751D-04 (SO-20L) ISSUE E

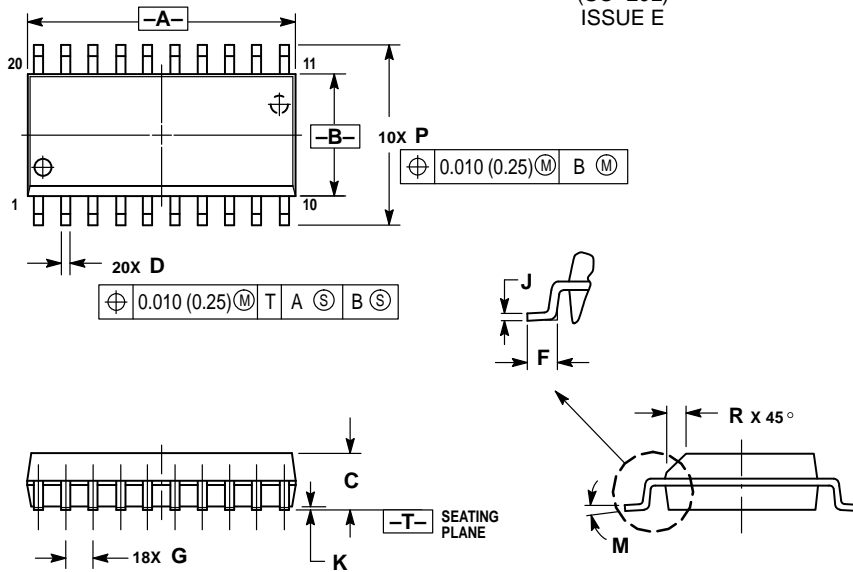

NOTES:

1. DIMENSIONING AND TOLERANCING PER ANSI Y14.5M, 1982.
2. CONTROLLING DIMENSION: MILLIMETER.
3. DIMENSIONS A AND B DO NOT INCLUDE MOLD PROTRUSION.
4. MAXIMUM MOLD PROTRUSION 0.150 (0.006) PER SIDE.
5. DIMENSION D DOES NOT INCLUDE DAMBAR PROTRUSION. ALLOWABLE DAMBAR PROTRUSION SHALL BE 0.13 (0.005) TOTAL IN EXCESS OF D DIMENSION AT MAXIMUM MATERIAL CONDITION.

DIM	MILLIMETERS		INCHES	
	MIN	MAX	MIN	MAX
A	12.65	12.95	0.499	0.510
B	7.40	7.60	0.292	0.299
C	2.35	2.65	0.093	0.104
D	0.35	0.49	0.014	0.019
F	0.50	0.90	0.020	0.035
G	1.27 BSC		0.050 BSC	
J	0.25	0.32	0.010	0.012
K	0.10	0.25	0.004	0.009
M	0°	7°	0°	7°
P	10.05	10.55	0.395	0.415
R	0.25	0.75	0.010	0.029

Motorola reserves the right to make changes without further notice to any products herein. Motorola makes no warranty, representation or guarantee regarding the suitability of its products for any particular purpose, nor does Motorola assume any liability arising out of the application or use of any product or circuit, and specifically disclaims any and all liability, including without limitation consequential or incidental damages. "Typical" parameters which may be provided in Motorola data sheets and/or specifications can and do vary in different applications and actual performance may vary over time. All operating parameters, including "Typicals" must be validated for each customer application by customer's technical experts. Motorola does not convey any license under its patent rights nor the rights of others. Motorola products are not designed, intended, or authorized for use as components in systems intended for surgical implant into the body, or other applications intended to support or sustain life, or for any other application in which the failure of the Motorola product could create a situation where personal injury or death may occur. Should Buyer purchase or use Motorola products for any such unintended or unauthorized application, Buyer shall indemnify and hold Motorola and its officers, employees, subsidiaries, affiliates, and distributors harmless against all claims, costs, damages, and expenses, and reasonable attorney fees arising out of, directly or indirectly, any claim of personal injury or death associated with such unintended or unauthorized use, even if such claim alleges that Motorola was negligent regarding the design or manufacture of the part. Motorola and  are registered trademarks of Motorola, Inc. Motorola, Inc. is an Equal Opportunity/Affirmative Action Employer.

How to reach us:

USA/EUROPE/Locations Not Listed: Motorola Literature Distribution;
P.O. Box 20912; Phoenix, Arizona 85036. 1-800-441-2447 or 602-303-5454

JAPAN: Nippon Motorola Ltd.; Tatsumi-SPD-JLDC, 6F Seibu-Butsuryu-Center,
3-14-2 Tatsumi Koto-Ku, Tokyo 135, Japan. 03-81-3521-8315

MFAX: RMFAX0@email.sps.mot.com – TOUCHTONE 602-244-6609
INTERNET: <http://Design-NET.com>

ASIA/PACIFIC: Motorola Semiconductors H.K. Ltd.; 8B Tai Ping Industrial Park,
51 Ting Kok Road, Tai Po, N.T., Hong Kong. 852-26629298

