

DATASHEET

Electrical & Mechanical Specification

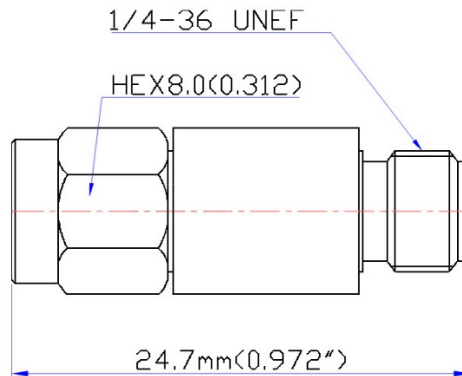

Frequency range	dc - 8 GHz
Attenuation	7 dB (± 0.6)
Power handling	2 W (bidirectional)
VSWR	1.20 (max.)
Impedance	50 Ω
Connectors	SMA plug / jack
Body material	Stainless steel
Body finish	Passivated
Center contact	Brass, BeCu / Gold plating
Insulator	PTFE



Attenuation & Return Loss Vs. Frequency

