

DATASHEET

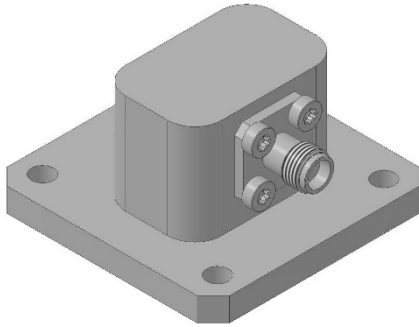

ELECTRICAL SPECIFICATIONS:

Frequency range	8.2 ÷ 12.5 GHz
Impedance	50 Ω
Return loss	≥22 dB

MATERIAL SPECIFICATIONS:

	Materials	Finishes
Body	Aluminium Alloy	Cu(5 μm) Ag(≥3 μm)

